



Downtown Spa

by **aquatica**[®]

Pre-Installation Manual

1: DOWNTOWN TECHNICAL SPECIFICATIONS

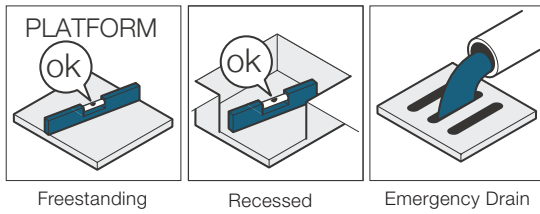

The manufacturer suggests a minimum load of 54lbs/ft².

DurateX Cabinet - Freestanding

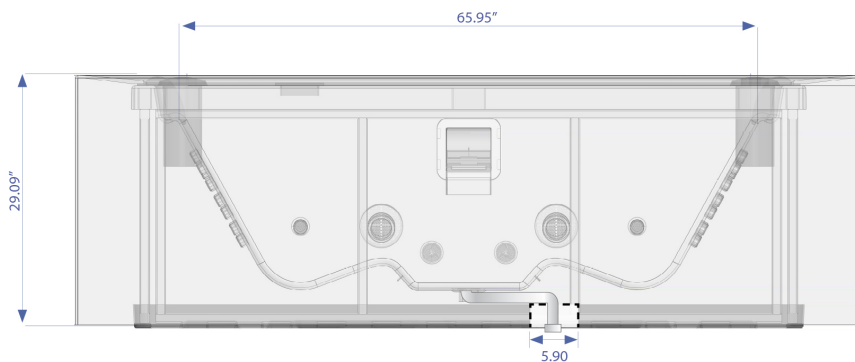
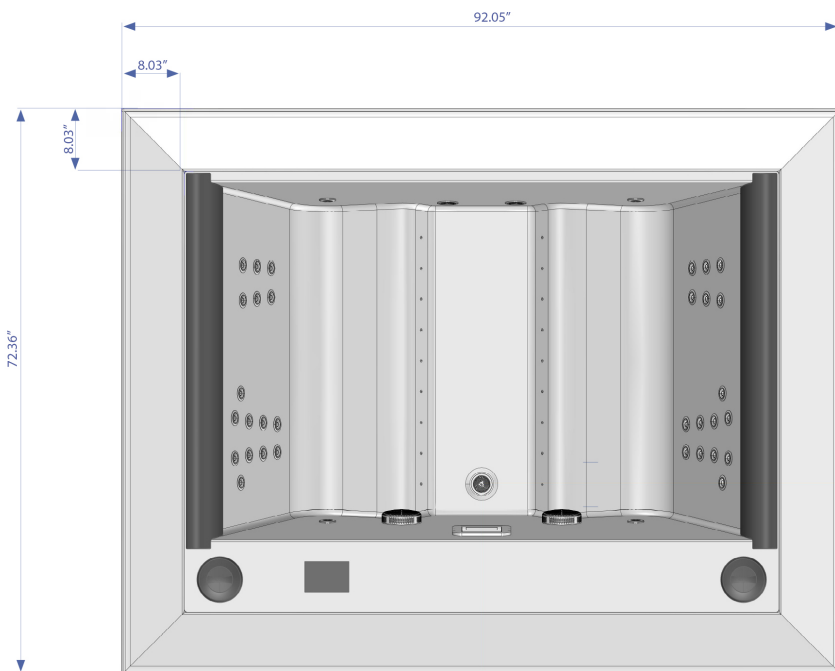

Maximum water content	137 Gallons
Weight with water	1631 lbs
Weight when empty	485 lbs
Voltage	220V
Amperes	30A Breaker
Whirlpool pump motor	2x2 HP
Recirculation motor	1/15 HP
Heating	4kW
Operating temperature	-23°F~+113°F

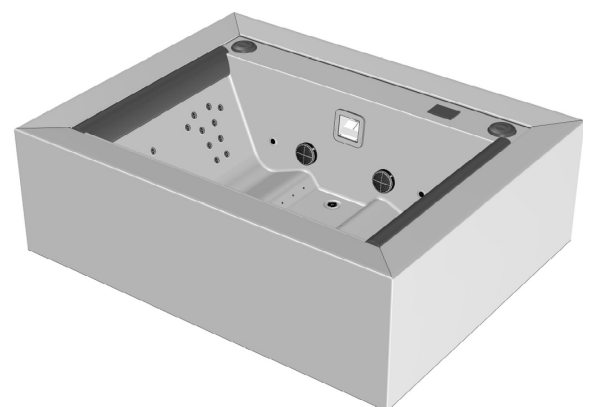

Downtown Spa by aquatica®

The spa works efficiently and safely if it is installed correctly and in compliance with the regulations in country of use.

This pre-installation guide provides information for a proper preparation of the environments and the plumbing and electrical connections. This allows for a quick and safe installation.

The pre-installation stages involve the following professionals:

- A construction engineer for the calculation of the loading capacity of the platforms or floors.
- A qualified and certified company that will prepare the installation site according to the instructions provided in this guide, following current work safety regulations.
- Certified and qualified electrician and plumber who prepare electrical and plumbing systems in compliance with local and national regulations regarding civil and industrial systems.

The user must promptly notify the professionals of any existing underground obstacles like gas or water lines and electrical or telephone cables.

Upon completion of pre-installation all these specialists must issue a declaration of conformity of the systems installed. Without such document, Aquatica declines any responsibility for damage to the systems or premises where the spa will be installed.

 We recommend checking with the appropriate municipal authorities to see if there are constraints that prevent installation or if permits might be required.

 An incorrect pre-installation could cause structural damage to the spa and void the warranty.

TEMPORARY POSITIONING

 The installation of the hot tub should be done immediately upon receipt.

In any case, once unpacked, if it is necessary to temporarily place it on a surface awaiting the installation, it will be necessary to place level concrete slabs having a minimum thickness of 5 cm under the entire bottom of the spa. **Since the temporary base may shift, it is recommended to leave the hot tub in that position for the shortest possible time.**

Do not leave the empty hot tub in DIRECT SUNLIGHT. The surface temperature could rise above 176F resulting in serious damage, including the deformation of the surface and components. Damage caused by direct exposure to sunlight is not covered by the warranty. In such conditions place a cover (fixed or mobile) to protect your spa unit.

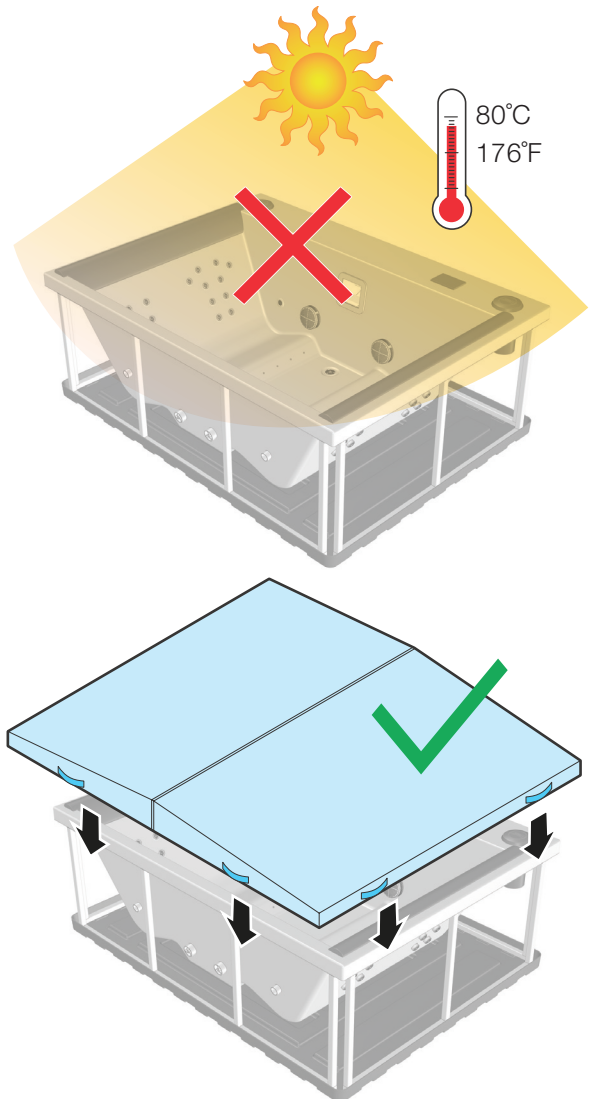

Please note

Aquatica cannot be held responsible and **does not recognize the warranty** in the case of:

- **Installations or connections that are not compliant** or that are carried out without following the national regulations concerning civil and industrial installations.
- **Pre-installation and installation carried out by unqualified personnel** or otherwise not in compliance with the instructions in the preinstallation and installation manuals.
- **Incorrect preparation of the installation environments**, including the supporting surface.
- Accidents and damage due to a non-compliant installation or use of the hot tub.
- **Masonry works** that prevent the removal and handling of the hot tub or defective parts thereof.

2: WHAT PREPARATIONS ARE REQUIRED?

To be installed, the hot tub requires:

- 1 Identification of the installation site.
- 2 Preparation of the installation site.
- 3 Preparation of the plumbing.
- 4 Preparation of the electrical system.

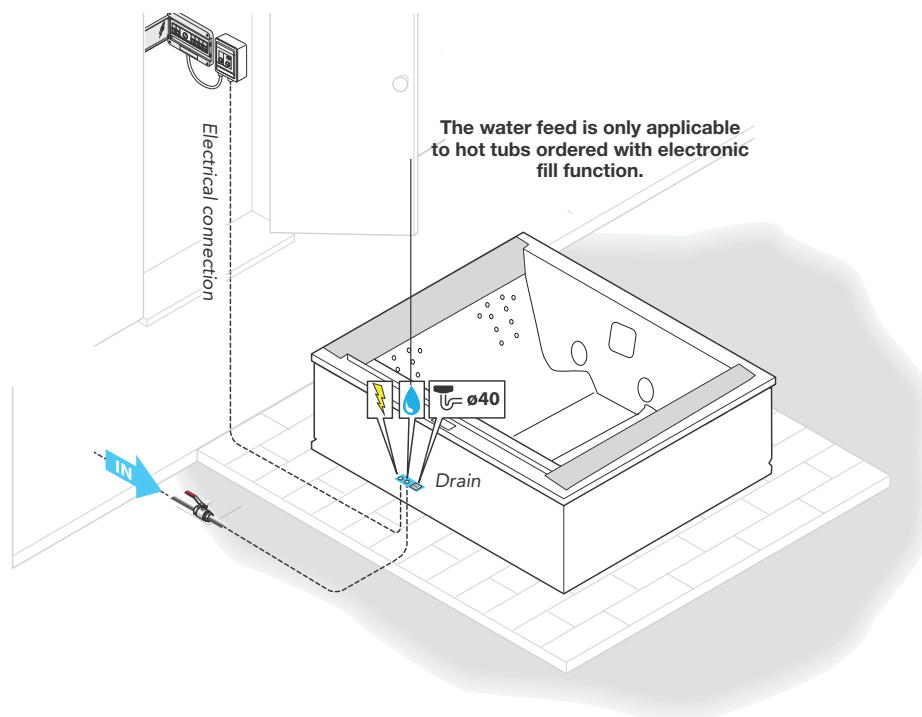

3: IDENTIFICATION OF THE INSTALLATION SITE



When choosing the position, take into account the **local electrical standards** that prohibit any electrical installation (plug sockets, switches, lamps, etc.) in the area surrounding the hot tub.



When choosing the position, bear in mind that the inspection side (electrical/plumbing components side) must always remain accessible for future maintenance.

The recommended ambient temperature for the bathtub must be between -23°F ~ $+113^{\circ}\text{F}$, with a relative humidity of 20-80%.

OUTDOOR INSTALLATION

Take into account the proximity of trees or hedges, and note that debris (e.g., leaves) that can cause damage to the equipment over time. Damages caused from debris is not covered in the warranty and can require frequent maintenance.

Also assess the best position to safeguard privacy and respect for others, as well as the best view or climatic position consistent with local regulations.

A sunny area with increased exposure during the morning ensures greater well-being for users!



Consider the geological composition of the soil on which the supporting platform will be built. Soils that are very sandy, permeable or subject to flooding could compromise the durability of the hot tub's support platform.

INDOOR INSTALLATION

Note that the evaporation of water in the hot tub in the presence of high internal temperatures can generate very high levels of humidity in the environment.

To overcome this drawback, choose an environment with good natural or forced ventilation. As an alternative, install a dehumidification system. Humidity damage is not covered by the manufacturer warranty. Take into account the size of the hot tub: narrow passages, doors and steps can be an obstacle to its transport to the desired place.

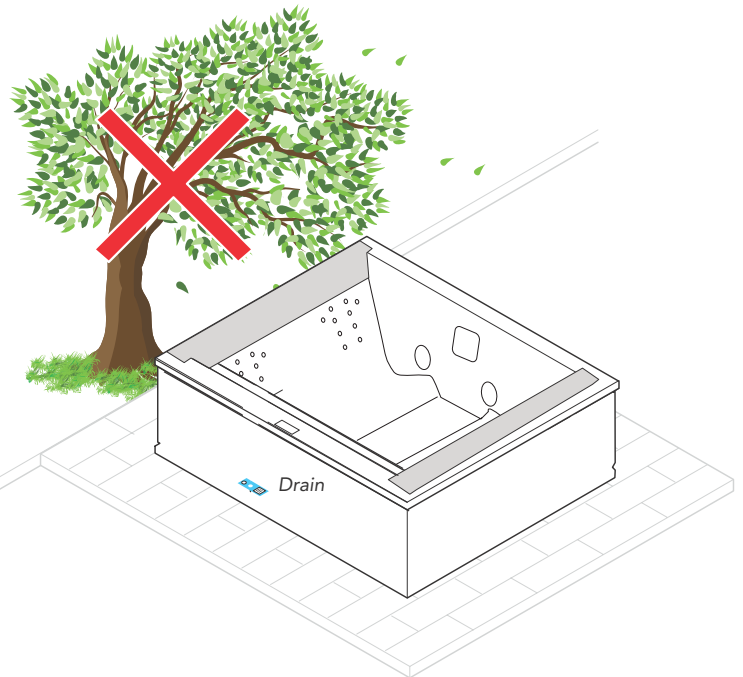

Please note

Our spas are built to be positioned outdoors.

If you install the spa indoors, remember that it must be able to be easily inspected or moved for any ordinary and extraordinary maintenance operations.

4: PREPARATION OF THE INSTALLATION SITE

FREESTANDING INSTALLATIONS

As a base, build a platform or flooring in reinforced concrete pads, at least 4" thick, perfectly flat and suitable for supporting the weight of the spa and the people using it.

The manufacturer suggests a minimum load of **54lbs/ft²**. In any case contact a qualified construction engineer to calculate the appropriate load for the installation site.



Wedges or shims cannot be placed under the hot tub to level it. Remember to ground the structural reinforcement in accordance with electrical codes.

Prepare:

- A** Drainage grating around the perimeter to help preserve the equipment and the structure (even for indoor installations).
 - B** Non-slip flooring around the hot tub - Recommended.
-  **For the preparation of the water and electrical connections reference the technical drawing.**

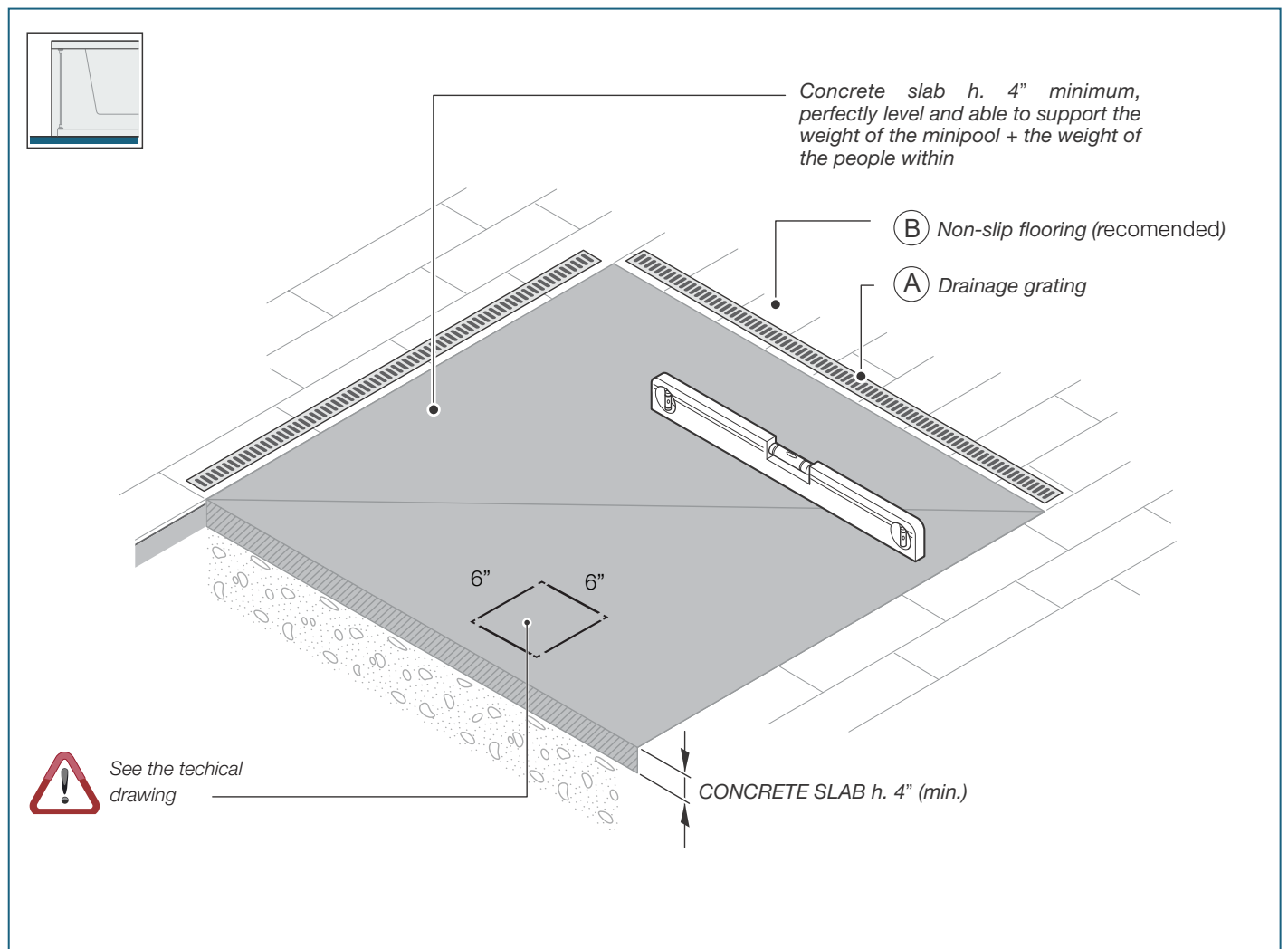

Downtown Spa by aquatica®

DOWNTOWN SPA FREESTANDING (DurateX Cabinet)

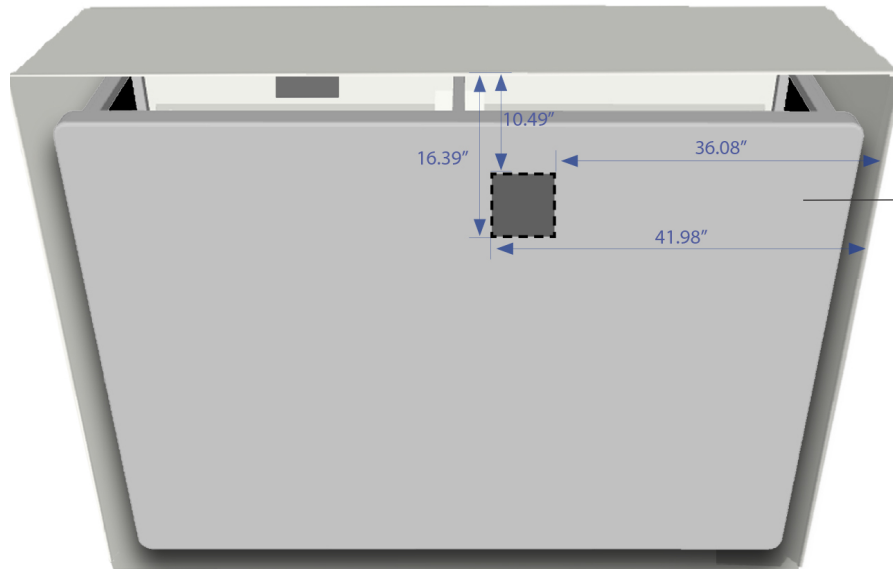
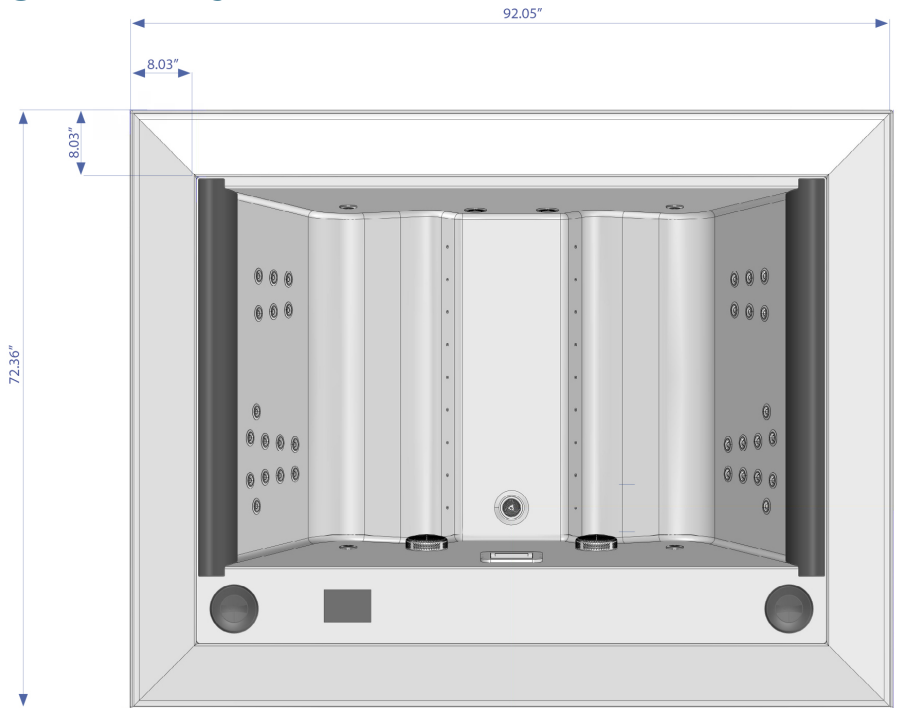

Base cutout for drainage, electrical feed and water supply (if applicable).

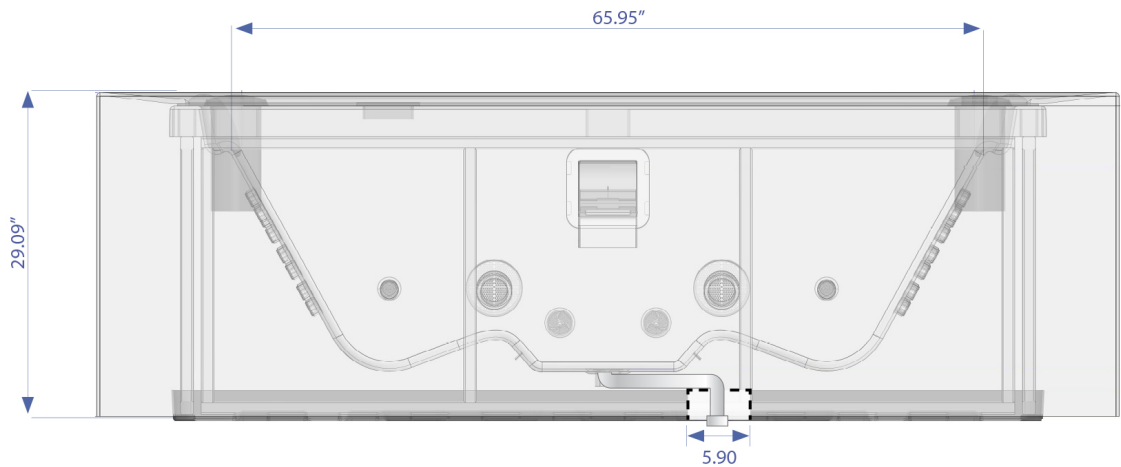

6: ELECTRICAL PREPARATIONS

Downtown Spa by Aquatica

Bond in accordance with national and local codes.

Open bonding lugs are located at the top of the junction box.

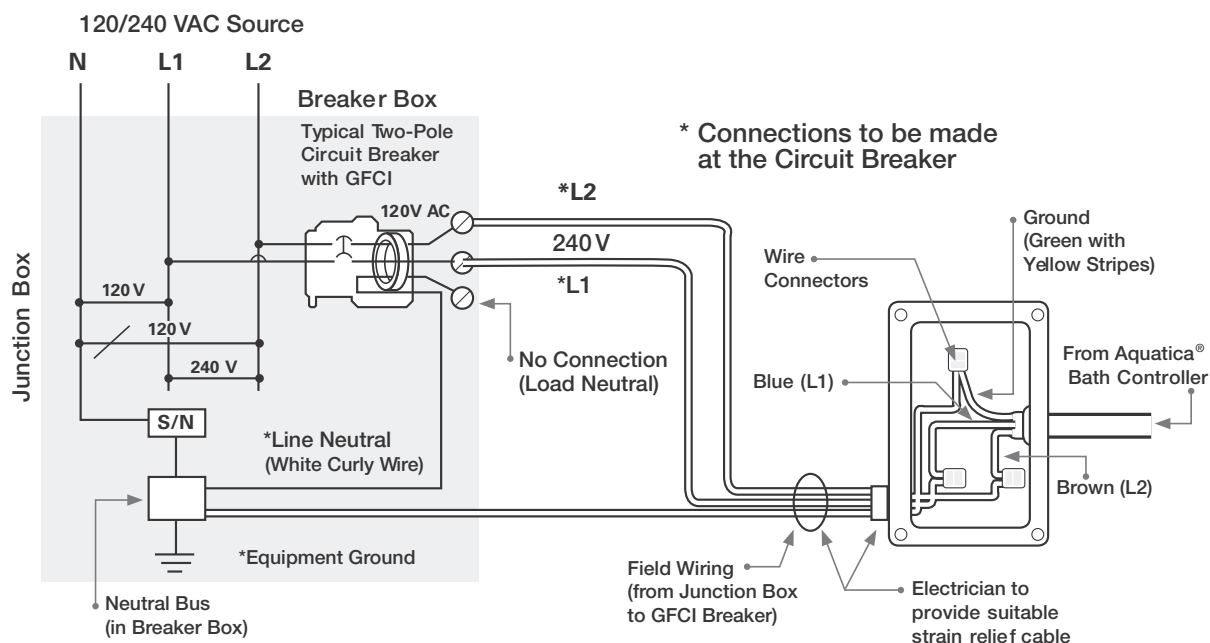

Make the Electrical Connections

IMPORTANT!

The Aquatica® Spa series hydromassage hot tubs come equipped with a wiring junction box and are designed to operate between 208 VAC and 240 VAC at either 50 Hz or 60 Hz.

IMPORTANT!

While the Aquatica® Bath Controller is designed to operate between 208 VAC and 240 VAC at either 50 Hz or 60 Hz, the pumps are market specific and require the correct frequency that is applicable for your specific market. Our US/Canadian Spa series bathtubs ship with 60Hz pumps, while our International models ship with 50Hz pumps.

WARNING!

Risk of electrical shock. Make sure the power has been disconnected before performing the following procedures. Refer to the "Important Information" section.

WARNING!

Risk of electrical shock. To reduce the risk of electrical shock, connect the system to properly grounded Ground-Fault Circuit-Interrupter (GFCI) or Earth-Leakage Circuit-Breaker (ELCB) - Customer Supplied. This will provide additional protection against line-to-ground shock hazard. One 30A 50/60Hz dedicated circuit is required.

IMPORTANT!

The load neutral is not used. There should be no connection to the load neutral terminal on the Ground-Fault Circuit-Interrupter (GFCI) breaker. The green wire with the yellow stripes is the equipment ground and needs to be connected to the neutral bus in the main circuit breaker box.

- The Aquatica® Bath Controller, pumps, blower, lights and heater have been pre-wired at the factory. A licensed electrician should make a routine service connection to the junction box.
- Connect service to the junction box. The junction box contains blue, brown, and green with yellow stripe colored wires.
- Follow local electrical codes. Bond in accordance with national and local codes.

aquatica®

Function : Form : Fashion

aquaticausa.com | aquaticabath.ca | aquaticabath.co.uk | aquaticabath.eu